

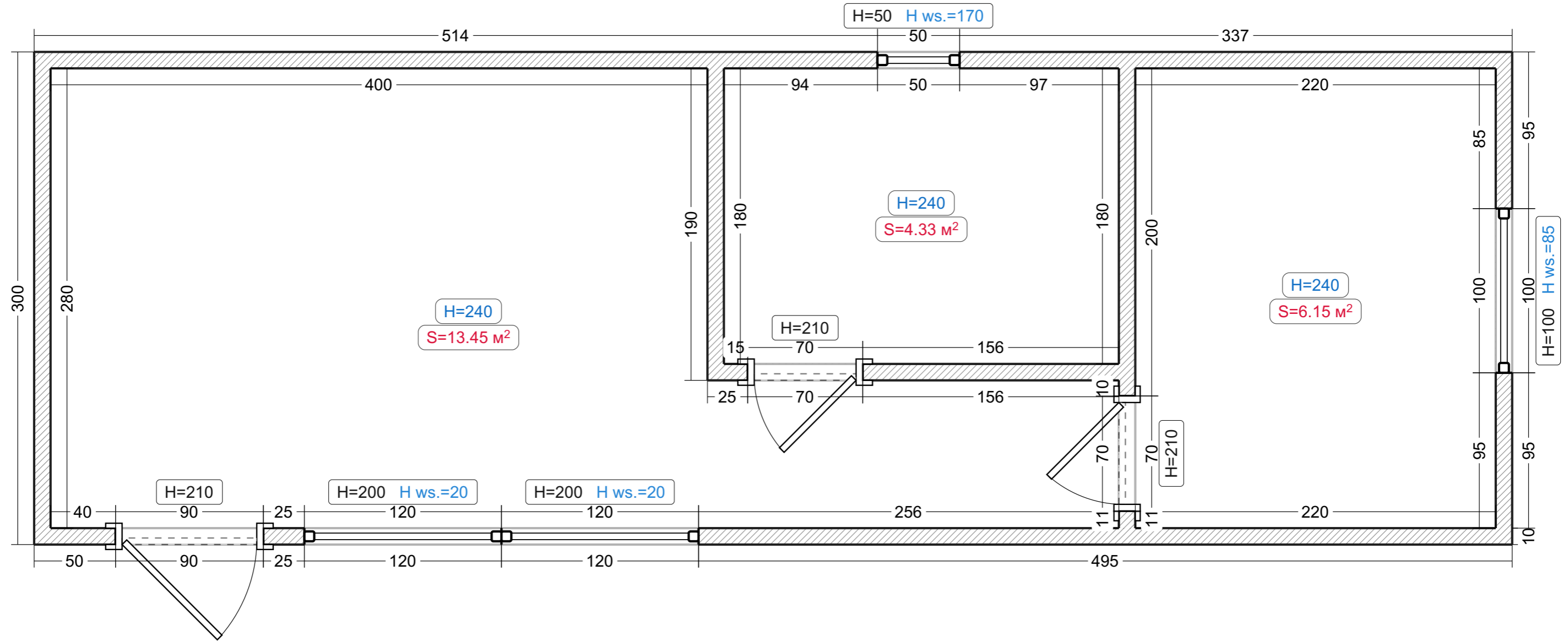

# Base plan



Legend:

 Existing wall

# Heating

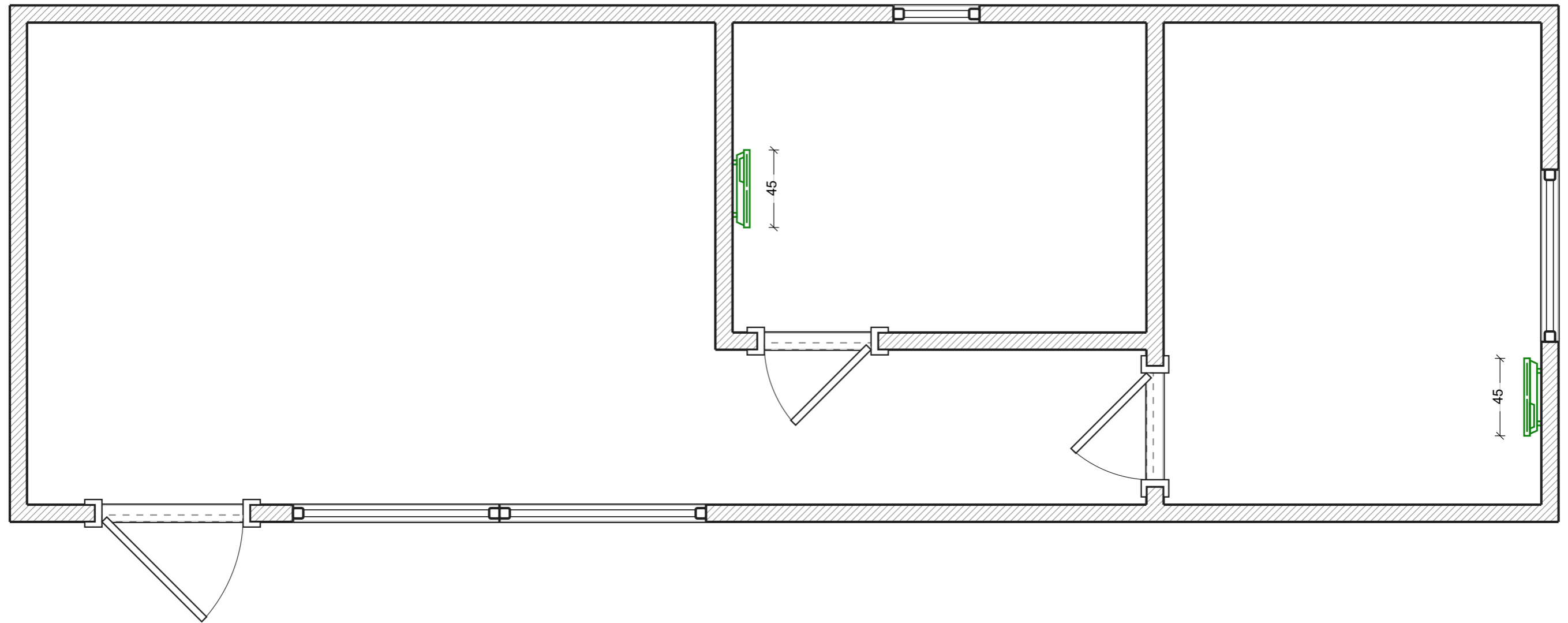

Furniture

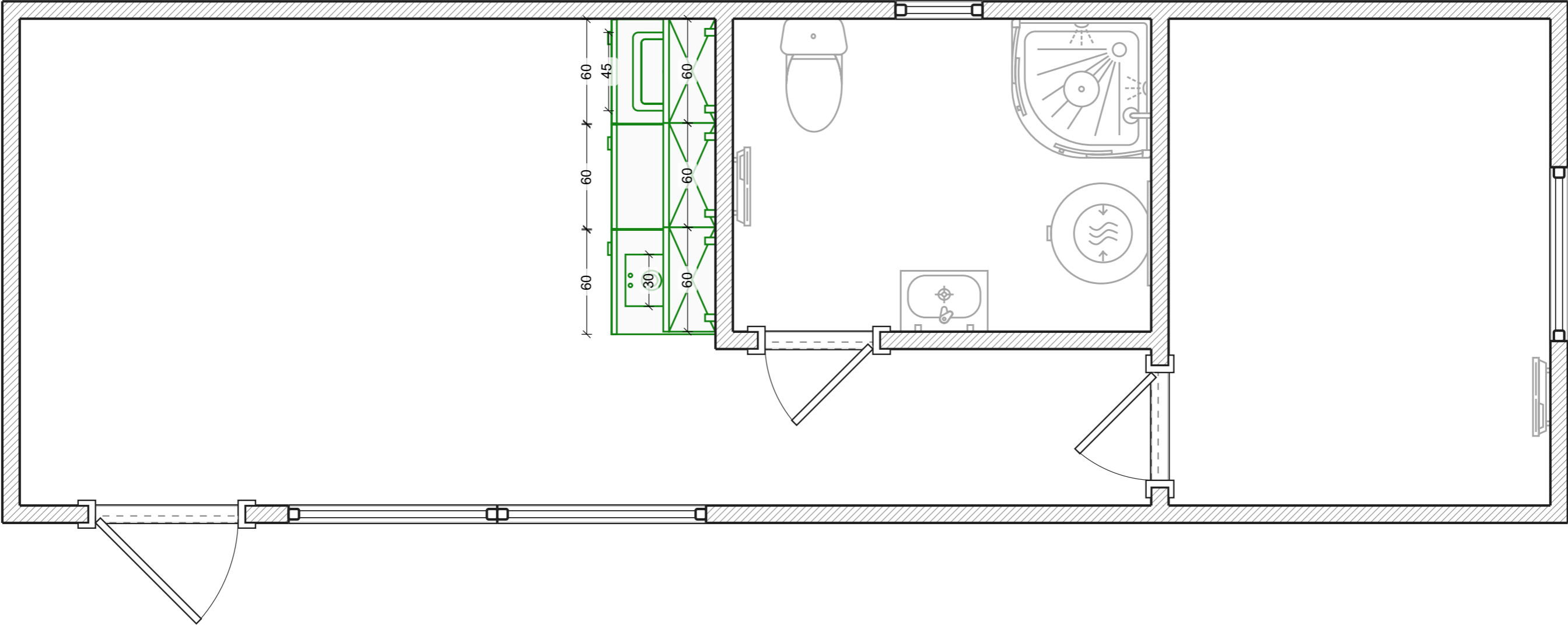

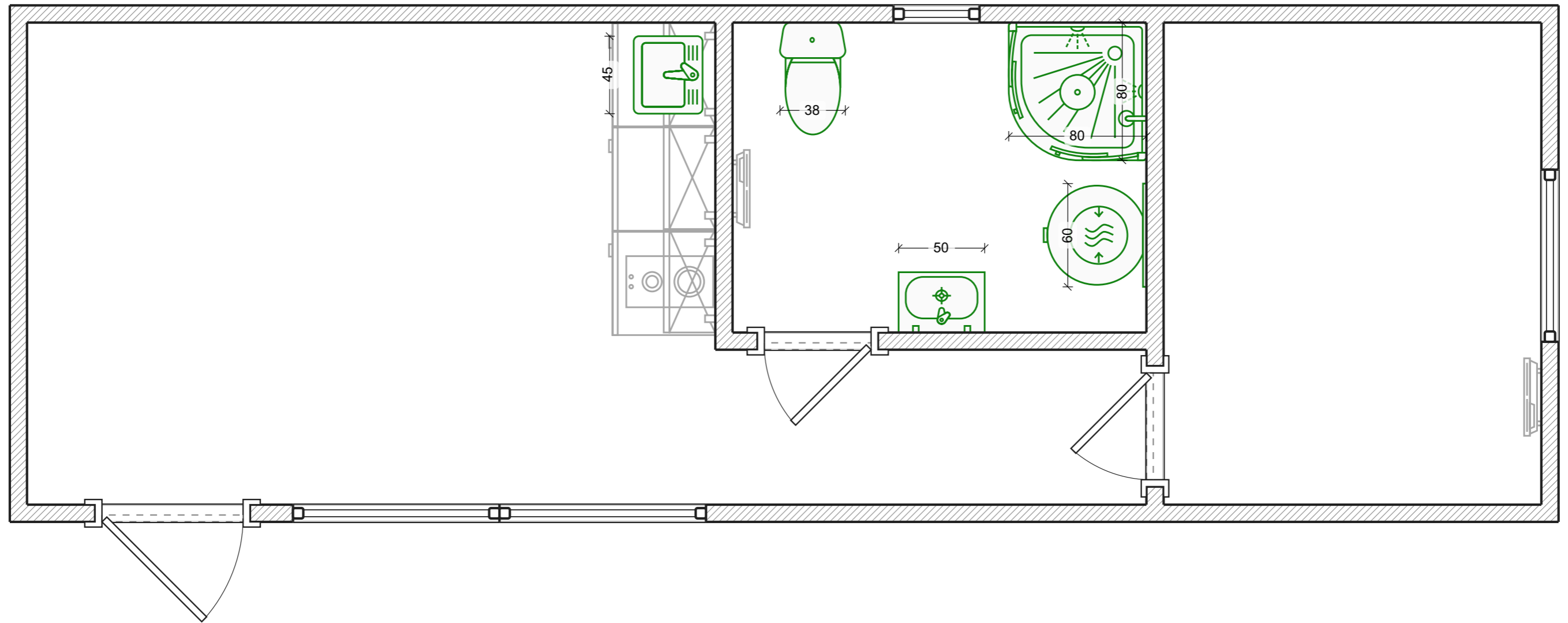

# Plumbing

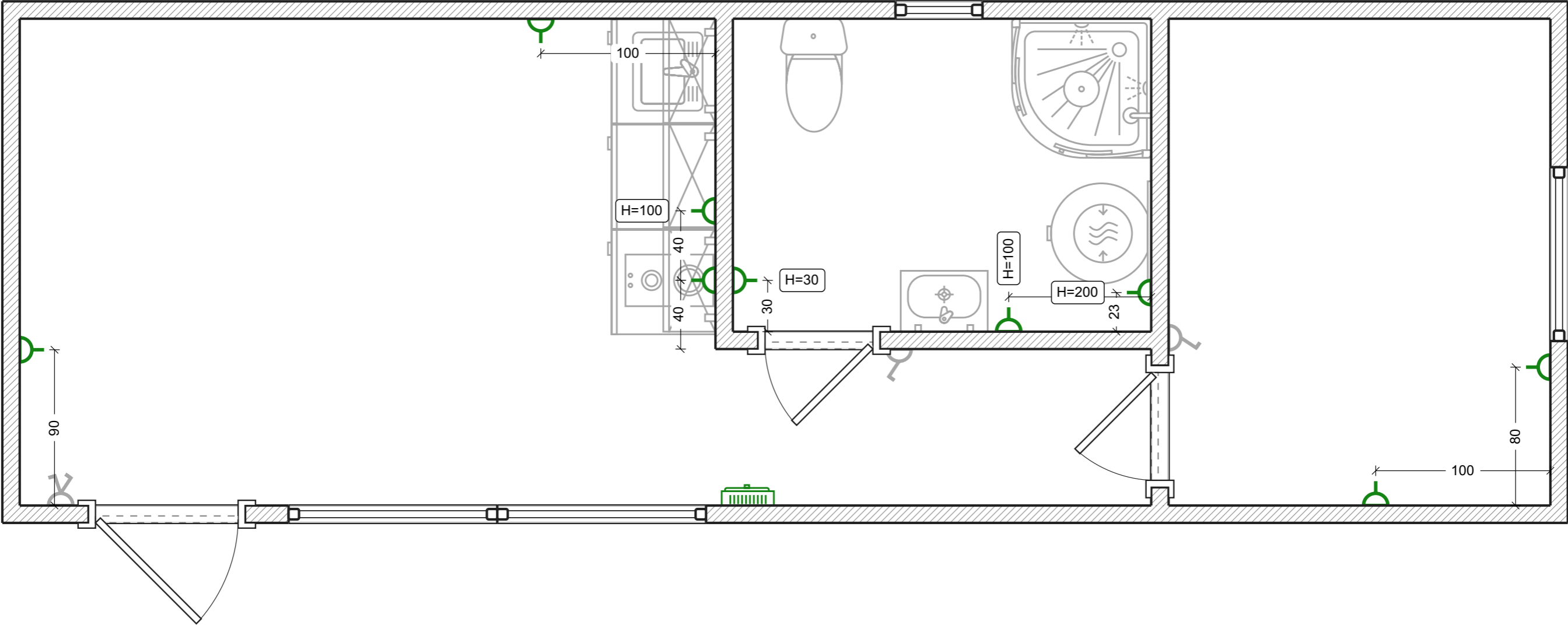

# Sockets



Legend:

-  Standard socket
-  Overhead switchboard

# Lighting

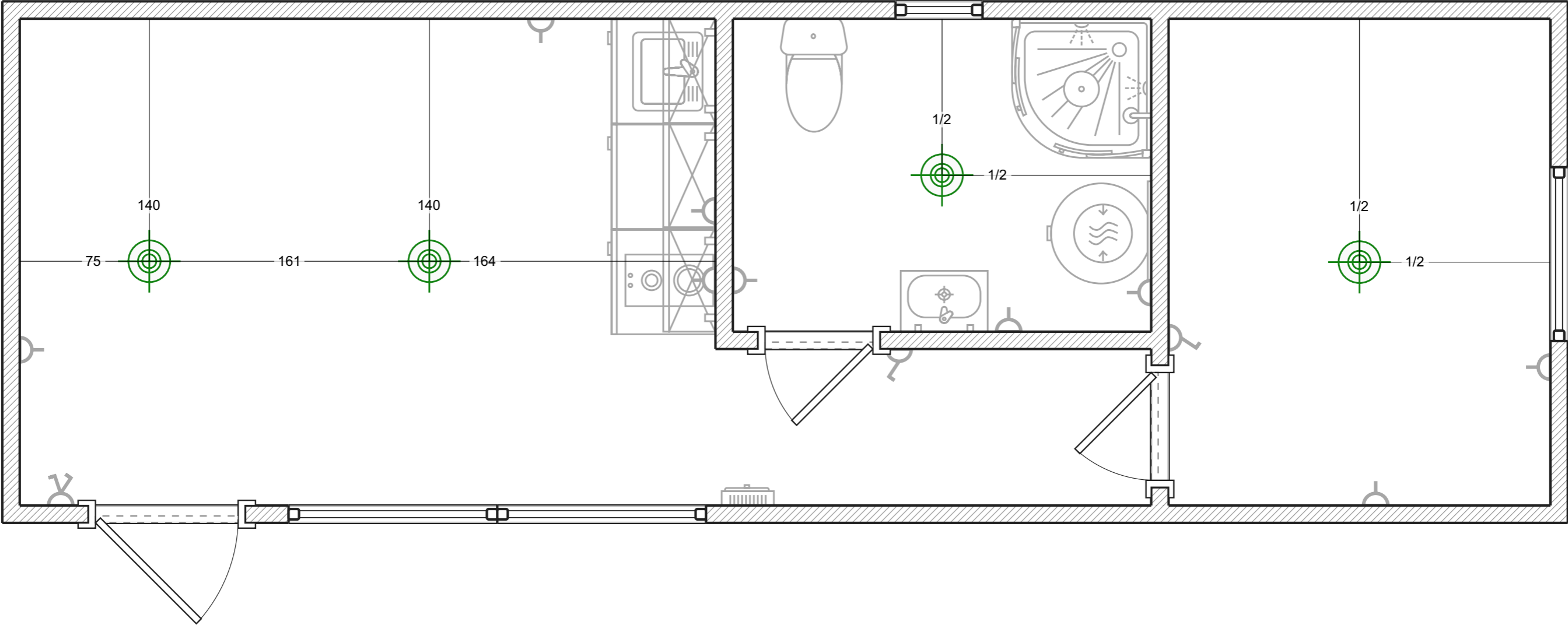



Legend:

 Hanging light

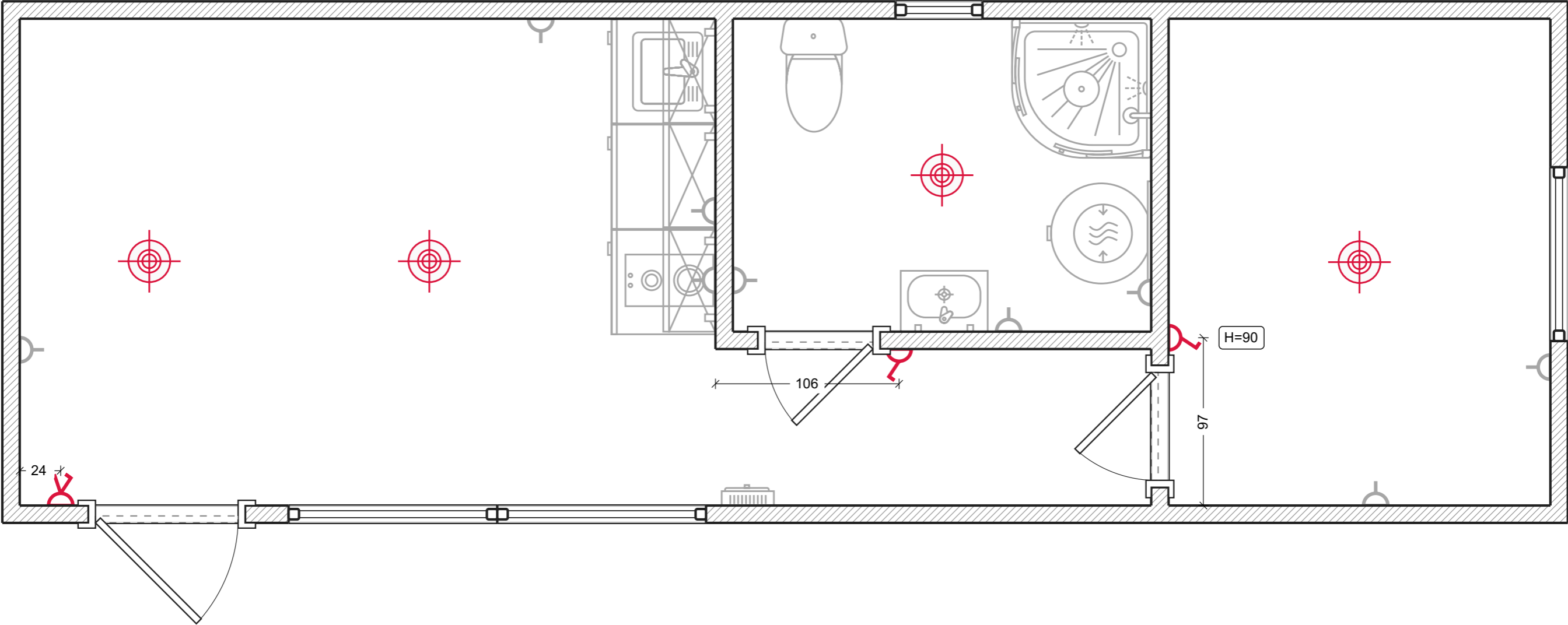
# Switches





Legend:

-  1-way switch
-  2-way switch

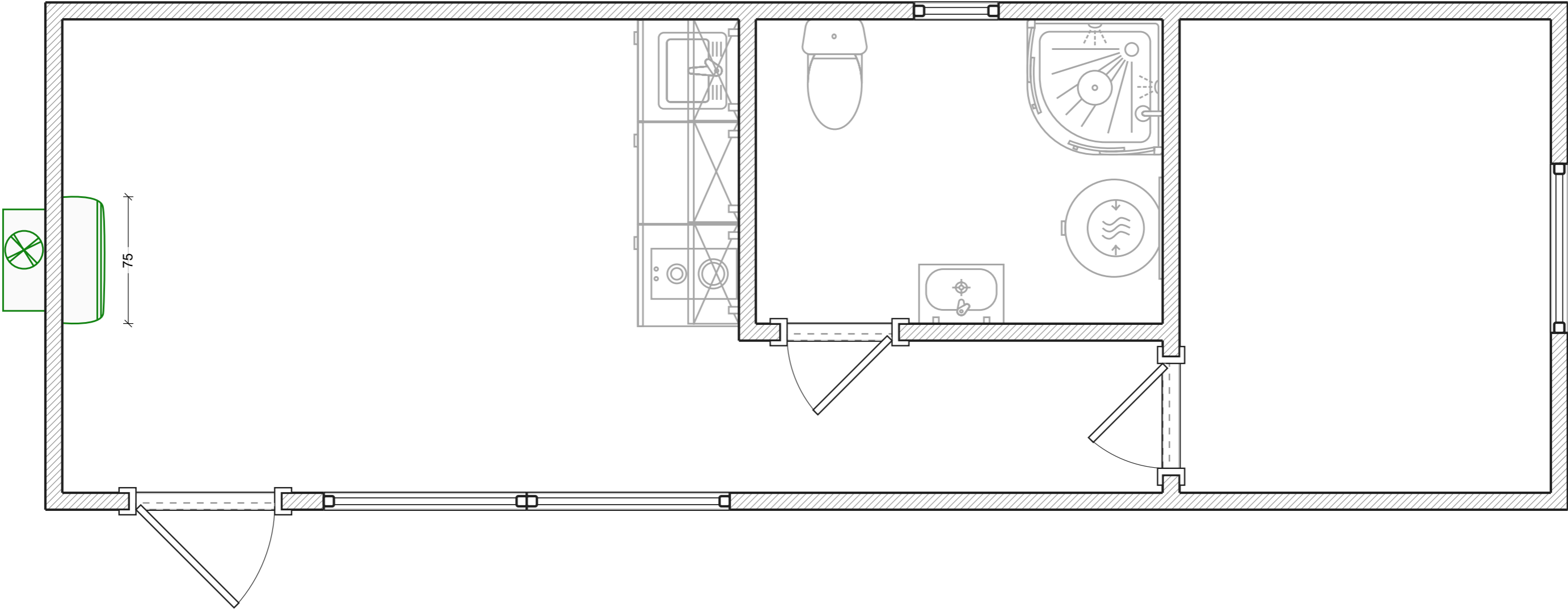
# AC Systems



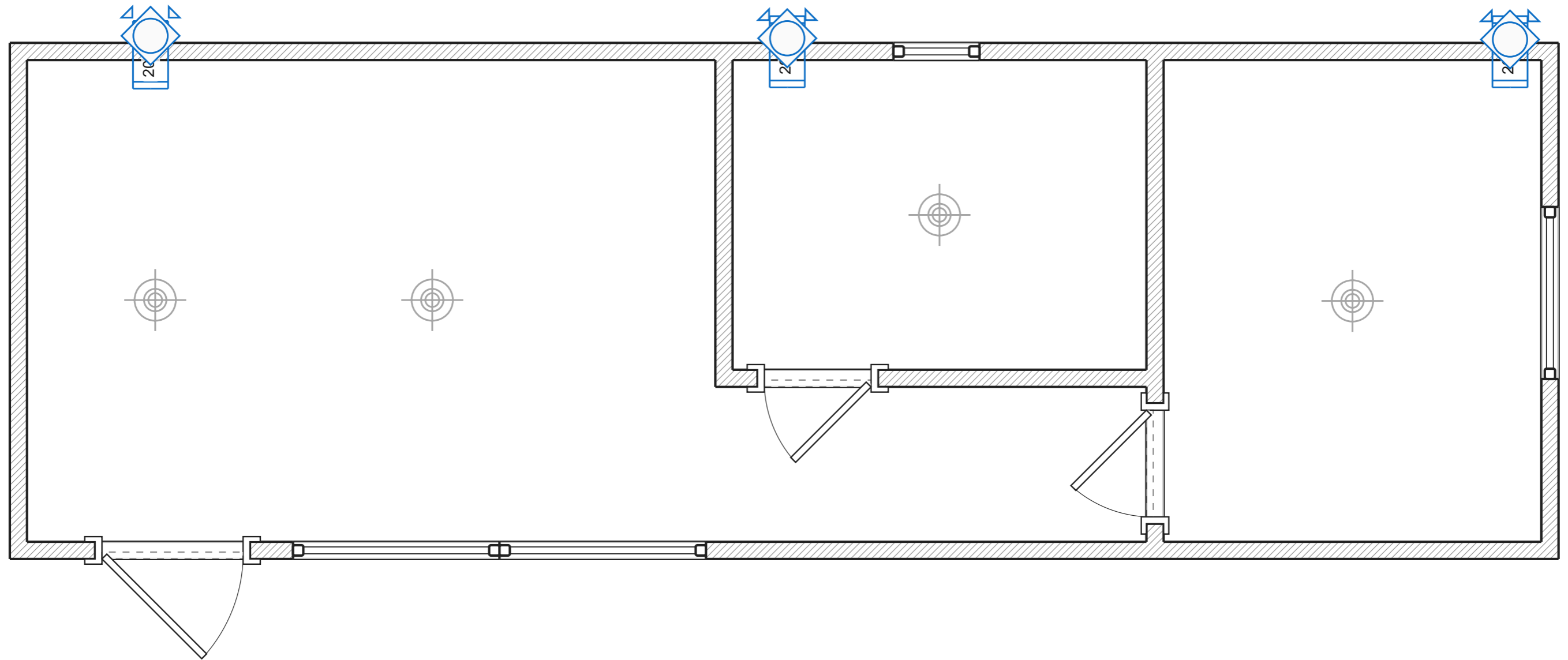

- Legend:
-  Outdoor split system unit
  -  Indoor split system unit

# Ventilation



Legend:

 Exhaust air duct

 Round grille

# Wiring

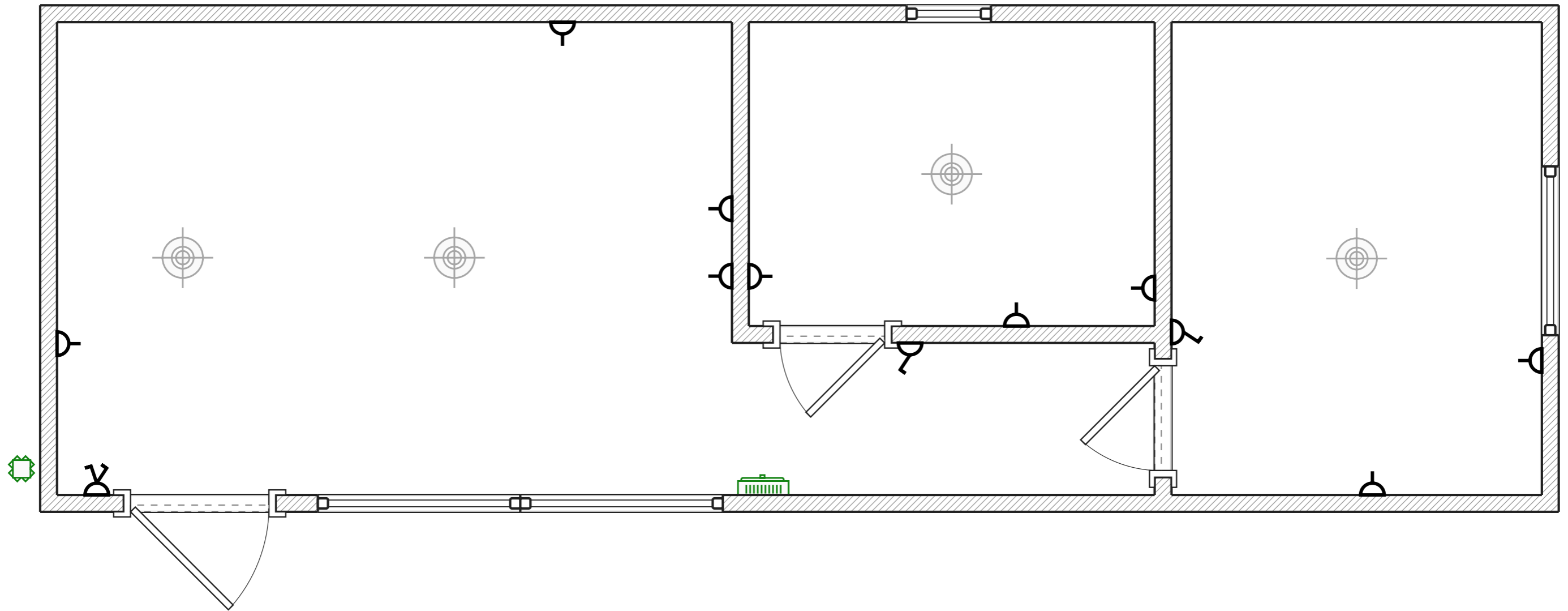

Legend:

 Overhead switchboard

 Junction box

# Wall elevations

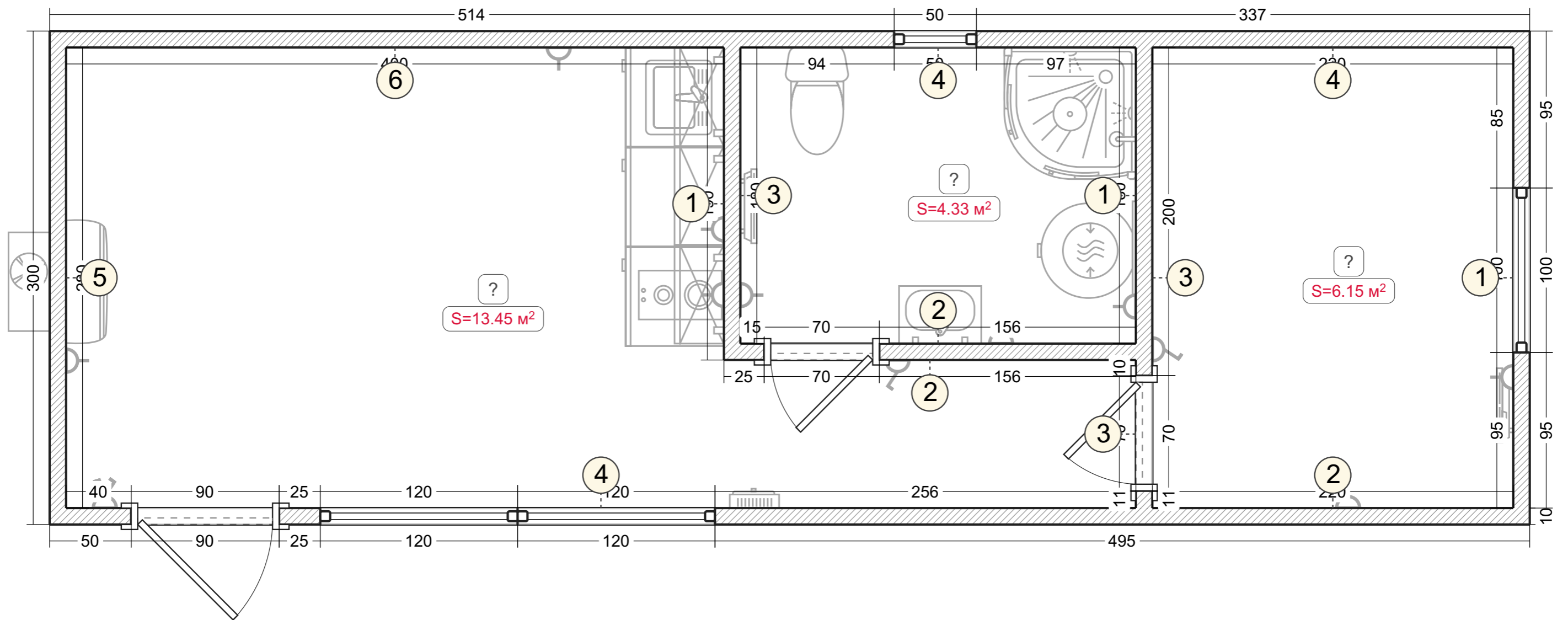

# Wall elevations Unnamed room (1-6)

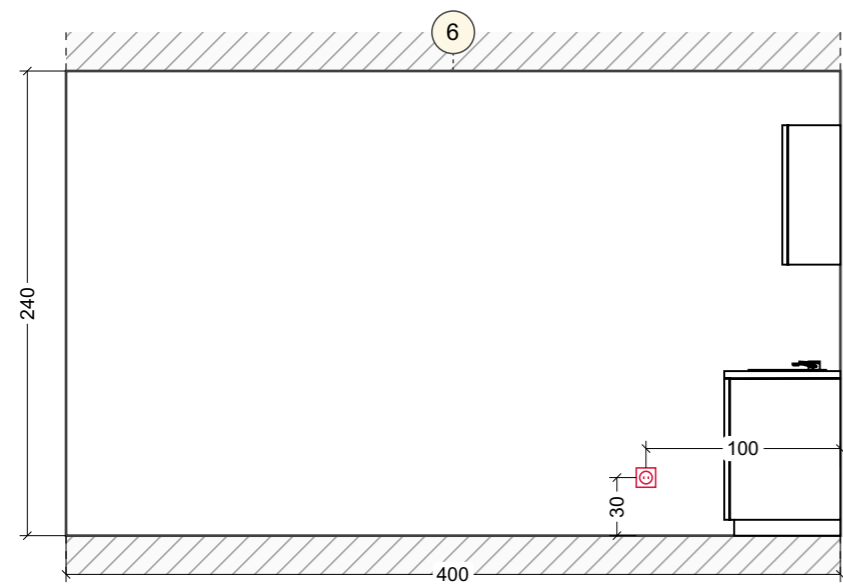
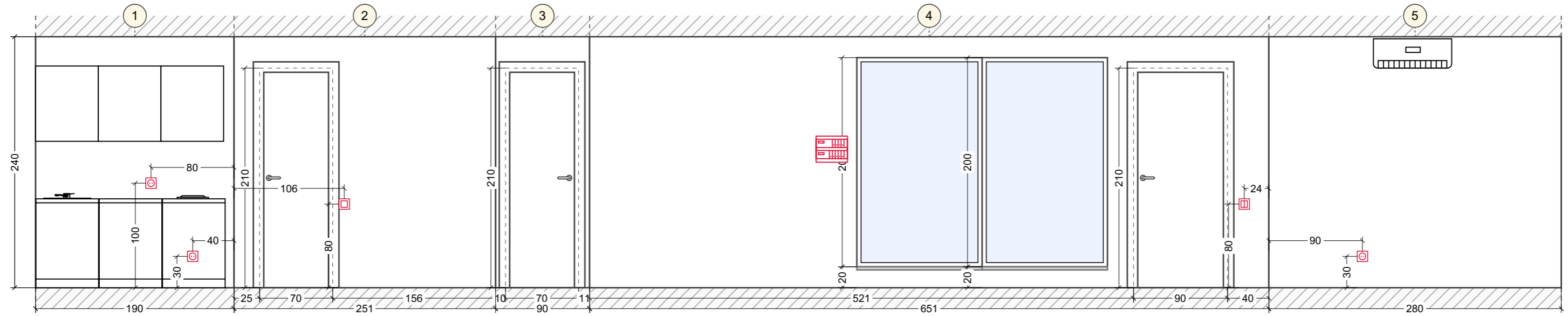

# Wall elevations Unnamed room (1-4)

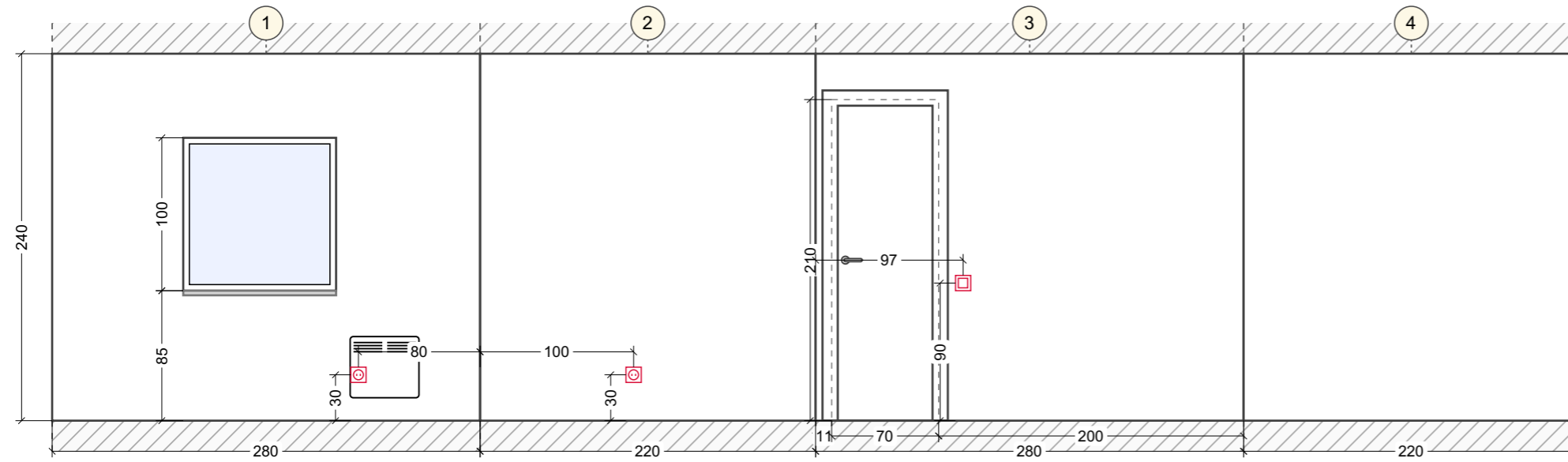

# Wall elevations Unnamed room (1-4)

